



KUZMA 4POINT TONEARM

Instruction manual

Serial Number:

2023-06

KUZMA LTD

INSTRUCTION MANUAL FOR 4POINT tonearm

The 4POINT tonearm is a very precisely engineered piece of equipment, however, the construction is robust and requires minimal maintenance for optimal performance.



Fig.1

CONTENTS:	Page
General description	3
Product registration and warranty extension	3
Technical data	4
Unpacking and Basic Setup	5-6
Setting up the tonearm	7-9
Adjustment of tracking force	9
Adjustment of tangential geometry	9
Adjustment of VTA	10
Adjustment of azimuth	10
Adjustment of bias	11
Damping	11-12
Adjustment of cueing device	13
Maintenance	13
Transport	13
Troubleshooting	14
Technical appendixes-set up cartridge	15-19
Protractors	20

General description

This differs from other arms by incorporating several unique features. The zero play bearing is configured on 4 points. There is very precise VTA adjustment and, despite a longer effective length of 280 mm (11 inches), fits the standard mounting distance of 212mm (for 9 inches arms).

The heart of the new construction is a unique 4 point bearing. The first set of two points (similar to a double unipivot bearing) allows vertical movement. The second set of two points allows horizontal movement. All four points have minimal friction and zero play in all playing directions thus ensuring the cartridge platform and the cartridge itself move with very low friction and minimal vibration across the record. It is normal to feel slack in the bearings in certain directions.

The whole construction is mounted on a rigid VTA tower which allows very precise VTA adjustment while playing, without any loss of rigidity, yet with up to 0.01 mm of precision and zero play.

The main tube is constructed and machined from solid aluminium, similar to our tangential Air line arm. The main counterweight balances the tonearm and there is a second small counterweight with which the tracking force can be finely adjusted. Azimuth can be adjusted in small repeatable increments with zero play, by means of an Allen key.

A feature of the tonearm is a unique detachable headshell(one spare included as standard). The electrical connection is via standard pins but the headshell can be simply removed by unscrewing with an Allen key. The headshell is fixed with a precise hexagonal locking system giving the same rigidity as with a fixed headshell.

Two separate troughs damp vertical and horizontal resonances and can be finely adjusted independently. The troughs can be removed from the tonearm.

Internal wiring is of superior special alloy silver wires. One set of 4 wires runs unbroken from the cartridge pins to the RCA plugs.

Product registration and warranty extension

Kuzma products have a non transferable 2 year limited warranty on parts and labour, which may vary in each country.

To obtain the 5 years* limited warranty from us, you need to register the product on our web site within 30 days of purchase. We suggest registration of products in any case because this will also help you to receive our technical support more easily and with resale of products.

Simply register on our web site, complete the forms and you will receive an extended five year warranty card on your email within a few days. * not valid for ex demo products.



Fig. 2

Technical data:

Mass:	1650 gr
Effective length :	280 mm (11 inch)
Mounting distance:	212 mm
Offset angle:	19.50 degrees
Distance from spindle to horizontal bearing:	264 mm
Effective mass:	18 g
VTA adjustment:	yes
Azimuth adjustment:	yes
Bias adjustment:	yes
Vertical damping:	yes
Horizontal damping:	yes
Detachable headshell:	yes (one extra supplied)
Cables:	silver
Arm mount:	Kuzma 212 mm
Optional:	biwiring wiring, extra headshells

1. Unpacking

Open the box carefully and remove top covers.

The tube with vertical bearing points is packed separately (tube assembly) on the top of the box. Please do handle with care and when put aside, ensure that nothing is touching the bearing points. Bear in mind how you will handle the termination box and output cable.

The horizontal bearing assembly is permanently mounted on the main VTA arm tower. This is blocked during transport. (Fig.2A)

First remove the armbase and prepare it for fixing onto the turntable. Be sure that the armboard on the turntable has the correct cut-out (main central hole must be 40 mm in diameter).

2. Basic set up

Armbase:

Mount the armbase on the turntable on distance of 212 mm! If the pre-cut has a thread, then use three screws and fix them from the top through the armbase into the armboard thread. A second way is to use a ring underneath and fix three screws (M5) into this ring, which will then hold the armbase very tightly. Be sure that you position the armbase so as to give access to an Allen key for fixing arm into armbase (towards the back of the turntable). Also check, when mounting the arm on other turntables, that you allow enough clearance for counterweights and correct position of the tube in relationship to the platter. Due to the bearing construction, there is only a limited arc which the arm tube can travel in a horizontal way. Rotation of the VTA arm tower of the arm, to achieve the correct distance of 264 mm, is done with a protractor after the basic setup.

VTA arm tower:

Insert the VTA arm tower into the armbase. Ensure that the height is such, that the top surface of the platform holding cueing device is at the same height as the record. Fix it with an Allen key. The vertical bearing cups should be at the same height as the record. Also check that the VTA adjustment is in the middle position, to allow fine VTA adjustment up and down 5 mm each way.



Fig.2A. Pull out fixing foam on the horizontal bearing assembly

With 1.5 mm Allen key, release the height ring which is on the fixing pillar below the VTA arm tower. (Fig. 2A) Now it will drop down and touch the armbase. Fix the ring again and release the VTA arm tower. You now have the correct height but you can freely rotate the VTA arm tower horizontally. Rotate it to such a position that the distance from the centre of the record to the centre of the horizontal bearing is 264 mm. (Use protractor by gently pulling apart trying to achieve max distance) Now fix VTA arm tower. (Fig.3)



Fig.3 Protractor for pivot to spindle distance



Fig.3A Black cable holder

Remove the fixing foam on the horizontal bearing assembly (Fig.2A). **When tonearm is shipped by airmail, courier service insert foam back!** Check that the bias thread is fixed and gently rotate horizontal bearing assembly from one to another extreme. It is only possible to make approximately $\frac{1}{4}$ of a turn. It is normal to feel slack in the bearings.

Tube assembly:

Carefully take the tube assembly with cable and gently position it around the horizontal bearing assembly so that **both** two points will fit into the appropriate bearing cups. Position it into the armrest.

(Fig. 2, 3A,3B,&4)

Remove cable from the tube assembly by releasing the black cable holder from the transport position with the 1.5 mm Allen key. Fix it to the empty pin at the back of the VTA tower, below the VTA locking lever. Fix it in such way, that the naked wires will go upwards towards the tube in a loop (Fig 3A). Be sure, that the VTA arm tower is fixed in the armbase, because the weight of the cable might otherwise rotate it. (Fig.1)

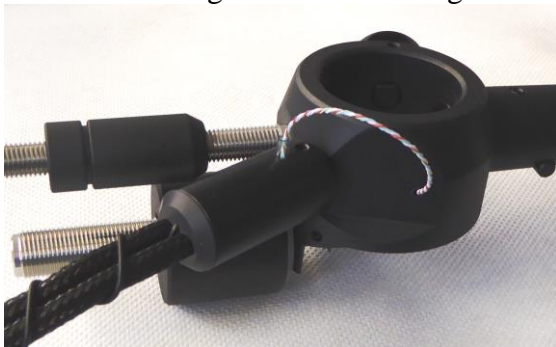

Fig. 3B. Tube with cable-transport position

3. Setting up the tonearm

Connecting tonearm:

Check the horizontal movement of the tube to ensure that the headshell will reach the inner grooves (approximately to the edge of record label), but will not travel to the centre of the record. Also check the arm wire loop and connect the tonearm cable into the phono sockets of the preamp. (Fig.1)

Due to the high tonearm mass, turntable levelling and suspension should be checked and adjusted according to the turntable manual.



Fig.4. Assembling the tube onto the horizontal bearing tower.

Cartridge mounting:

Mount the cartridge with the appropriate set of 2.5 mm screws. When fixing cartridge pins be sure that you do not damage wires under insulation tubes! If you wish you can fix fingerlift at the side of the headshell- no key required.(Fig. 7A)

Headshell removal and fixing:

This tonearm has a detachable headshell and fixing and positioning it has no negative effect on tonearm performance. The whole headshell is fixed with one Allen key 2 mm.

Insert it in the top hole and release screw with Allen key for at least one turn (ACW). (Fig.5&6)

Disconnect cartridge pins, remove Allen key and pull out the headshell. (Fig.7)

Fix the cartridge and return headshell back in to the tube. If it can not be inserted easily, rotate the screw a little more in ACW direction. Then fix it back in CW direction with gentle force, around one turn.



Fig.5 Locked



Fig.6 Unlocked

Note: Do not over-tighten the screw which locks the headshell.

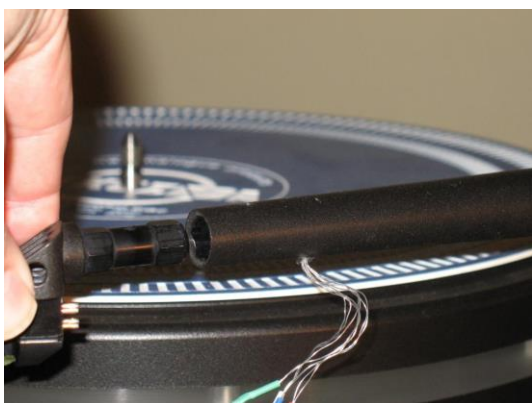

Fig.7 Removing headshell



Fig. 7A Headshell's fingerlift

Balancing of the tonearm:

Fix cartridge pins. Add counterweights to the lower threaded carrier, starting with the longest counterweight, then a plastic ring and another counterweight, until the tonearm is roughly balanced. Be sure to fit the plastic rings that separate counterweights and, at the same time, allow them to fit together. (See Fig.2 and counterweight configuration)

Knowing the approximate mass of the cartridge, enables choice of the correct configuration of different counterweights. Aim for roughly zero balance. Even if the counterweights are not screwed to the end, as long as you rotate two against each other, they will be fixed on the thread. The main long counterweight (28 mm) remains fixed on the tonearm. You can use any mix as long as you can achieve the desired tracking force.

Counterweight configuration:

Cartridge weight:	counterweights configuration (gr)
0-4 g	+20 (3.5 mm)
6g	+30 (5 mm)
8g	+40 (7 mm)
10g	+50 (8.5 mm)
12g	+40+20
14g	+40+30
16g	+50+30
18g	+50+40
20g	+50+30+20
22g	+50+40+20
24g	+50+40+30
26g	+50+40+20+20
28g	+50+40+30+20
30-32g	+50+40+30+20+20

Move the small upper counterweight for more precise balance, by rotating. The tonearm's centre of gravity is chosen to be around the height of vertical rotation. Therefore balancing the tonearm to zero is very difficult. Adjust it to be roughly balanced and increase tracking force with smaller counterweight.

If this is too loose, hold the front part of the counterweight and rotate the rear part until there is a tighter fit, or lock it into position on the threaded carrier. Opposite rotation will make the smaller counterweight looser. (Fig. 2)

4. Adjustment of tracking force

Balance the tonearm with the tracking scale, which must be at record height. Rotate the smaller counterweight towards the tube. Rotation for one turn (observe red dots) will change tracking force for approximately 0.1g. If you are unable to obtain the correct tracking force, add or remove main counterweights. By rotating two counterweights along the thread you can obtain the desired balance. Then simply rotate them one against other and this will fix them. (Fig.1)

Check that the cueing device is at the correct height (see paragraph 10).

5. Adjustment of tangential geometry

Put a record on the platter and adjust VTA in such a way, that the central axis of the tube will be parallel to the record. This is only a starting point for VTA.

Using the protractor, adjust geometry at two null points. Rough guidance is by the edges of the cartridge body, but accurate adjustment is by observing whether the cantilever and lines are parallel at the two null (zero) points.

See appendix 1.

6. Adjustment of VTA

It is extremely easy to set up VTA on this tonearm. Just unlock the lever at the back and rotate the VTA knob. VTA knob rotation CW- VTA down (Fig.1)

VTA adjustment between any two lines is 0.1 mm (the whole rotation is then 0.8 mm) which allows for very fine repeatable adjustment. The rigidity of the assembly is such that even in the unlocked position you will not feel slack. Move the tonearm VTA to the desired height. Simply lock the lever back with gentle force. Observe the 1 mm scale at the left hand side of tonearm tower. If you run out of range (10 mm), then you must reposition the tonearm height in the armbase. However take into account what is the optimal VTA by listening.

Once you find out the correct VTA, rotate outer ring of the VTA main knob and position it into null position. This is now your starting point for very fine tuning.

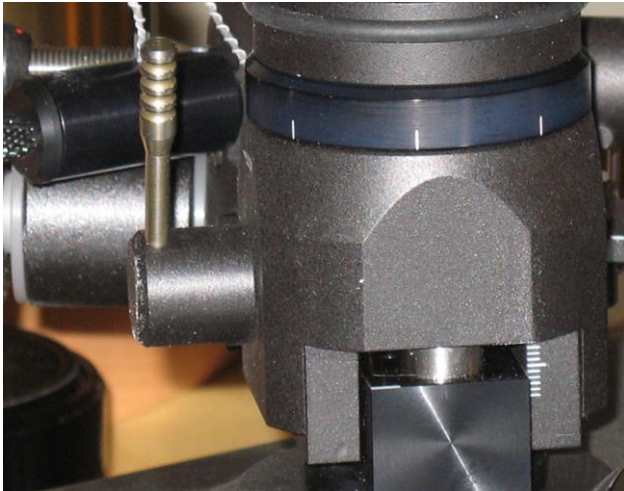

Fig. 8 VTA tower side-rough scale

7. Adjustment of azimuth

To make azimuth adjustments, release the two screws locking the mechanism at the centre top of the main tonearm tube, with Allen key 2mm. Under the main tube is a tiny rod with a hexagonal screw. Insert the Allen key 2 mm into the screw (it may feel loose), rotate it slightly and it will alter the azimuth. (Fig.2)

Rotating it back will bring azimuth to its previous position. Changes can be seen by misalignment of the white lines on the top of the centre of the tube. Even 15 degrees rotation of the Allen key will make a significant difference.

See appendix 2.

8. Bias

The bias should be adjusted roughly according to the tracking force. Using Allen key 1.5 mm, unlock the screw on the bias weight and position it to the equivalent of gap X to your chosen tracking force. Lock the screw back, when in position.



Fig. 9 Bias adjustment

X	P
mm	gr
0	1.00
4	1.50
8	2.00
10	2.25
12	2.50

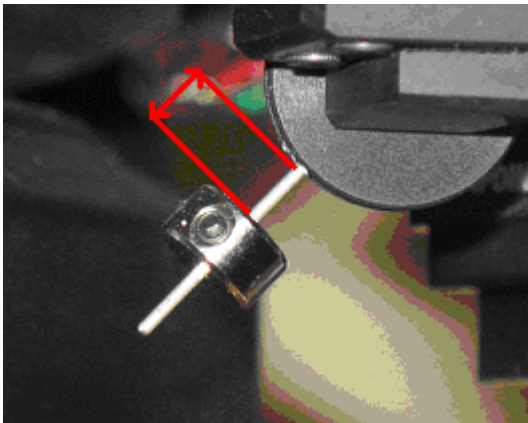

Fig. 9a Bias distance "X"

For maximum tracking, it is advisable to set the bias by use of an appropriate test record, i.e. those with tracking bands. Please do not use test records with blank space where the tip of the needle sits on the surface rather than in the groove. (Fig.9&9a)

See appendix 3.

9. Damping

This tone arm has two independent damping systems. The lower trough is for horizontal damping and the second trough on the arm tube assembly is for vertical damping. (Fig.1)

Both troughs are removable.

The horizontal holder with paddle is permanently fixed on the horizontal bearing assembly.

Vertical& horizontal damping:

The vertical paddle is inserted after the tube assembly. Fix holder in the hole with 1.5 mm Allen key. (Fig 10)

The paddles long screws (1.5 mm Allen key) are fixed with fingers by a small black plastic nut. Start with both at zero damping. The more the paddle is inserted into the liquid, the stronger the damping. First start with horizontal, then add vertical, but feel free to experiment.

Be sure that you do not adjust the paddle in the trough so that it touches the bottom.



Fig.10 Fixing vertical damping holder

Paddles are fixed by holding a screw with Allen key 1.5mm and ACW rotation with fingers of the small black nut.

Adding damping oil:

First insert silicone damping oil into the troughs. Let the liquid settle, before adding more. Stop filling, when you reach the silver lines about 3mm below the edge of the troughs.

Removing trough:

Removing trough using Allen keys 1.5 mm (vertical- fig .11) and 2.5 mm (horizontal- fig.12&1). Release fixing screw and pull away trough. But firstly put paddles in the vertical position out of the oil so that oil will drip off.



Fig.11 Removing vertical trough

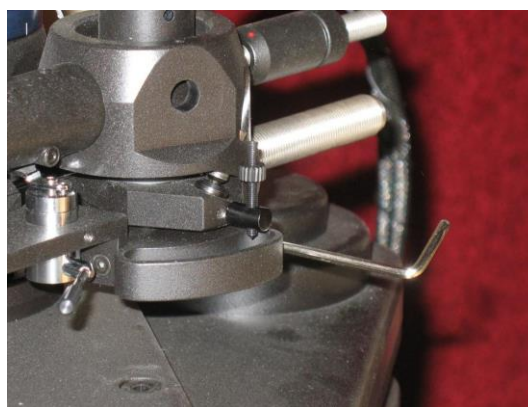

Fig.12 Removing horizontal trough



Fig.13 Both troughs removed

10. Cueing device adjustment

Should you find that in the 'up' position the cartridge is too high or too low above the record then the cueing device can be raised or lowered. This can be done simply by using Allen key 1.5 mm:

Insert key into screw on side of arm rest.

Release screw, raise or lower device and retighten.

Rotation of cueing device can affect the drift of cartridge while travel vertically down.

The cueing device may lift slightly as the screw is retightened. Do not over-tighten as this may cause the cueing device to stick in the 'up' position. Should this occur, slightly release the screw. (Fig.9)

11. Maintenance

The bearing does not need maintenance. Clean dust from the tonearm with a dry cloth and use a soft cloth and alcohol to remove silicone oil.

12. Transport

During transport the tube assembly must be removed from the horizontal bearing assembly. To do this you must remove the vertical paddle. Remove vertical trough and reposition cable on the tube assembly. Fig. 3B. **REMOVE ALL SILICONE OIL!**

Return fixing foam below tower of the horizontal bearing assembly! See Fig. 14.

If you transport a turntable with tonearm, ensure that hard vibration from the car does not transmit directly to the tonearm. Placing soft material such as rubber, foam or a thick blanket below the turntable is helpful in filtering rough vibrations even when the platter is removed.



Fig.14. Insert fixing foam by lifting horizontal tower- see Fig. 2A

13. Troubleshooting

1. Cartridge jumps in the inner grooves: See if the tube can travel towards the centre of the record- check that position of the tonearm is correct with protractor for distance.

2A. Cartridge is too close to the record edge: Check if the tube travels too much toward the centre of the record- check that position of the tonearm is correct with protractor for distance and spindle to armbase distance is 212 mm.

2B: Cartridge is not reaching inner grooves: check that position of the tonearm is correct with protractor for distance and spindle to armbase distance is 212 mm.

3. Headshell cannot be removed- check that the screw is released enough with Allen key.

Kuzma Ltd
Jelenceva 1
SI-4000 KRANJ
SLOVENIJA
P: +386 4 25 35 450
E mail: kuzmaltd@siol.net
www.kuzma.si

Tangential Cartridge geometry adjustment

Once the cartridge has been mounted, it is necessary to ensure that the cartridge is tangential to the record grooves in order to minimize tracking distortion during playing. As the cartridge moves in an arc across the record, tracking distortion occurs and is minimized by the tonearm geometry and the angle of the cartridge in the headshell.

With optimum tonearm geometry, very low distortion levels (below 1 %) can be obtained across the entire playing surface. Cartridges have zero distortion at two points on a record and these points are used when aligning the cartridge. In practice these points lie at 66 mm and 121 mm from the record centre (see protractor). Other protractors make use of different zero points due to the use of different parameters in calculation. In this case 60 mm has been chosen as the inner groove and 146 mm as the outer groove which still has optimum tracking distortion.

1. Ensure bias is on minimum or switch off.
2. Place protractor over spindle on platter.

Note:

If you have difficulty seeing the cantilever it may help to raise the arm a few mm, taking care that the protractor does not rotate. This also prevents tilting of the cantilever due to the effect of bias force. It may also be helpful to fix the platter by inserting a wedge between platter and plinth and by inserting a sheet of white paper to give a clear background while observing the cartridge. Use a strong light.

3. Alignment at zero point 66 mm (A):

Place tip of stylus on point A (ie. zero point 66 mm). With a strong light observe cartridge from front. The cantilever and the line on protractor should be in perfect alignment.

If the cantilever is not, then the body of the cartridge will have to be rotated slightly.

Do not adjust cartridge by observing body of cartridge only. (Fig.14)

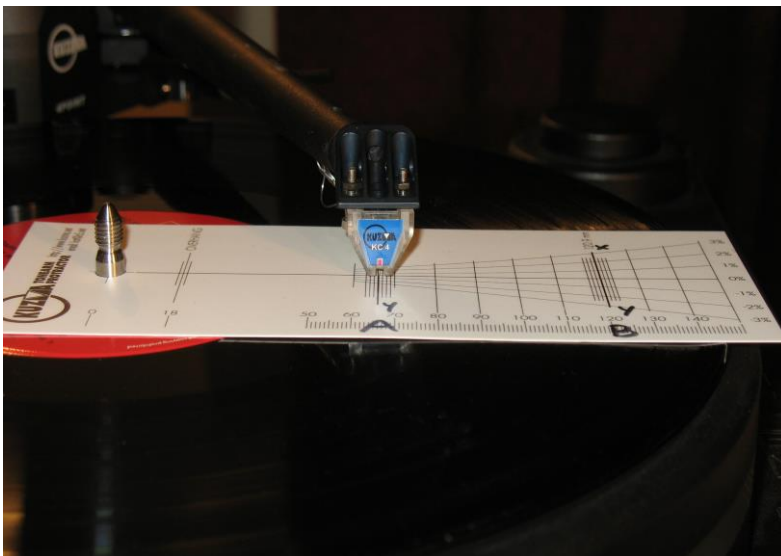

Fig. 14 Alignment at A

To rotate or readjust cartridge:

4. Slightly loosen the screws which attach the cartridge to the headshell.
5. Holding headshell in one hand slightly rotate the body of the cartridge.
6. Recheck alignment at position A and continue adjustment until line described in point 3 is achieved.

7. Alignment at zero point 121 mm (B):

Reposition protractor and check alignment at position B.

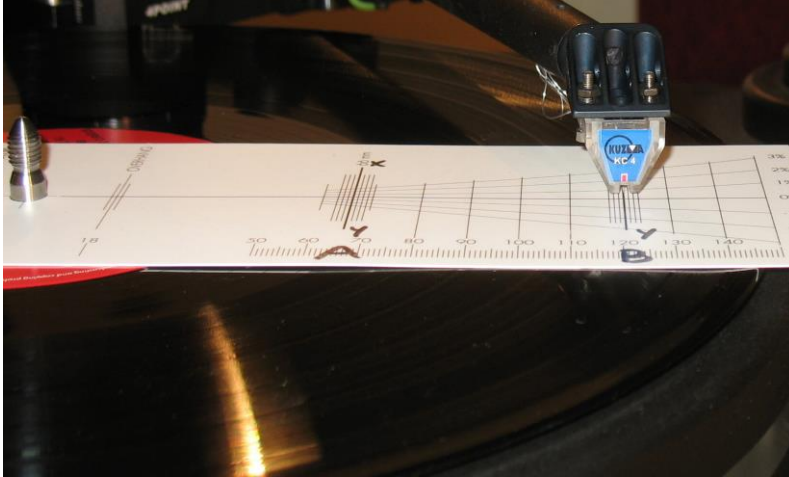

Fig. 15 Alignment at B

8. If the cantilever is not in alignment then rotate protractor until it is in alignment somewhere along the line “x-y” though stylus will probably not be at zero point B. Raise the cueing device a bit for better viewing. (Fig.15)

9. If stylus is in front of point B, pull the cartridge forward (along side) in the slots of the headshell for approximately the same distance “S” as stylus is overhanging zero point B. If it is behind point B, push cartridge backwards towards the pivots of the tonearm for distance “S” (Fig. 16)

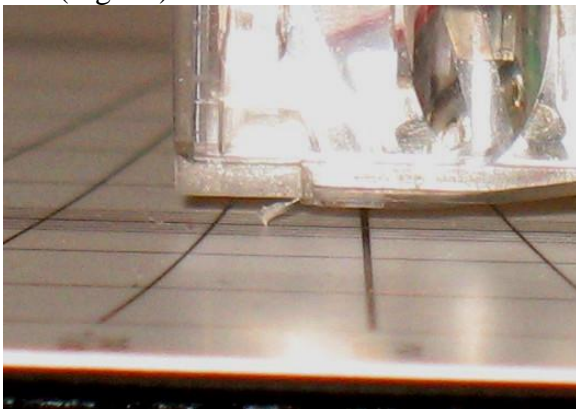

Fig.16 Stylus tip is in front of zero point B.

10. Now rotate protractor and again position stylus at zero point A as described in 5 and 6 above, ensuring that the position of the cartridge in the slots alongside is not changed but only rotated for alignment of the cantilever in zero point A. (Fig.17)

Fig.17 Rotation at A

11. Recheck alignment of the cantilever at zero point B. If cantilever is not aligned here, rotate protractor to find where on line “x- y” the cantilever is aligned again. (Fig.18&15)

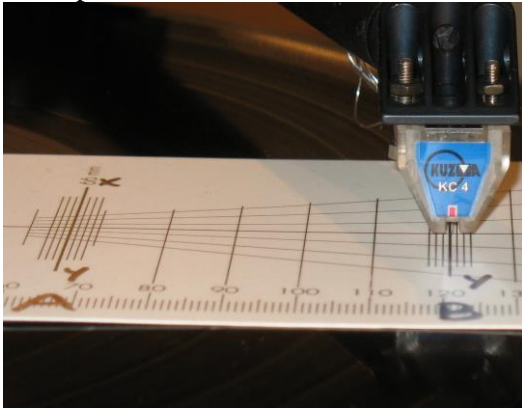

Fig. 18 Alongside line “X-Y” alignment at B

If the stylus is still in front of zero point B on the line “x-y” as before, but nearer to point B, then again pull cartridge slightly forward for distance “S” and repeat the whole process by aligning at zero point A until the stylus will be at zero point B.

If stylus end up behind the zero point B on line “x-y” then move cartridge in opposite direction to before, backwards and realign it at zero point A.

If stylus is still behind the B point, the cartridge should be pushed back and realign at zero point A and realigned again at zero point B.

12. Continue until the stylus is in alignment at both points.

REMEMBER STEPS:

- a) Put stylus at zero point A and by rotation align cantilever along XY line.
- b) Align cantilever along XY line at zero point B by rotating protractor and see where stylus is on the line XY- in front or behind zero point B.
- c) Move cartridge along (not rotating it) for the same distance as stylus is overhanging zero point B for the same distance to increase the overhang.
- d) Repeating these steps (a,b,c,a,b,c,...) will ensure that stylus& cantilever are in alignment at both zero points A&B.

NOTE: Ensure that cantilever is not twisted due to bias force.

Appendix 2

Fine Azimuth Adjustment

This can be done using an oscilloscope and a test record or by using good records in a good system and listening to the sound. Cartridges with fine profiles (VDH, Microline etc.) are more sensitive to this adjustment. On the other hand cheaper cartridges are not made so well, making fine adjustment more useful.

With an oscilloscope we measure the differences in crosstalk between both channel. The idea is that on both channels this is equally small. For that we need a test record with tracks recorded for left and right channels separately. Then we compare crosstalk from the left channel on the right channel- which is a very small signal, to the same type of signal from the other channel. By adjusting azimuth, crosstalk on both channels should be made equal.

Listening from LP:

Start listening with the tube in zero position, with the marking lines aligned. Listen to the sound-stage, the focus and the stability of the instruments. Release the two locking screws and rotate the Allen key so that tube rotates for approximately the width of the mark. Listen and then rotate tube for a similar amount in the opposite direction and again listen. Adjust the arm to the position in which the best sound was obtained. In this position make further adjustments by turning the Allen key for a quarter turn in one direction, listening and then turning a quarter turn in the other direction and listening.

Continue this process making ever decreasing adjustments, 1/8 of a turn, then 1/16 and so on. When optimum results are obtained fix the locking screws. To remember the position of the azimuth, imagine that the inserted Allen key acts as a dial on the clock.

NOTE: During fine adjustment only gently fix locking screws during listening.

The adjustment screw is highly sensitive and the smallest pressure on the Allen key will alter the azimuth and sound.

Do not attempt any adjustment when the locking mechanism is locked. Although no damage can be done.

Significantly improved sound can be obtained by paying attention to azimuth adjustment prior to final VTA adjustment.

Appendix 3

Fine bias adjustment

1. Set bias and tracking force as previously described and listen to mistracking on highly Modulated tracking bands on test record. On higher modulated bands mistracking can be heard as impure tones and there will be more overtones. (See instructions on test record)
2. If mistracking is apparent, increase or decrease bias until minimum mistracking is found.

If mistracking is heard on the right channel only then the bias is too low, if on both channels the bias is too high or the trackability limit of the cartridge has been reached.

3. Finally further decrease mistracking by increasing tracking force to the maximum Recommended for the cartridge.
4. It is best to have the highest possible tracking force and low bias force.

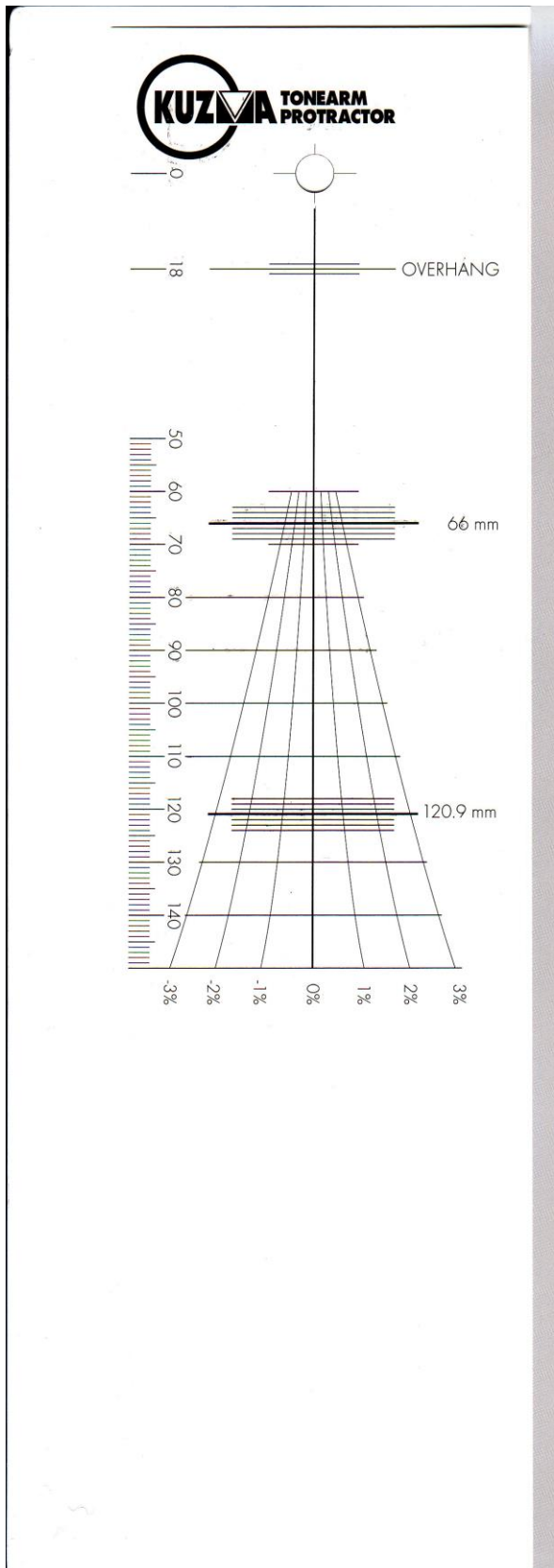

Tonearm Mounting Protractor
<http://www.kuzma.si>

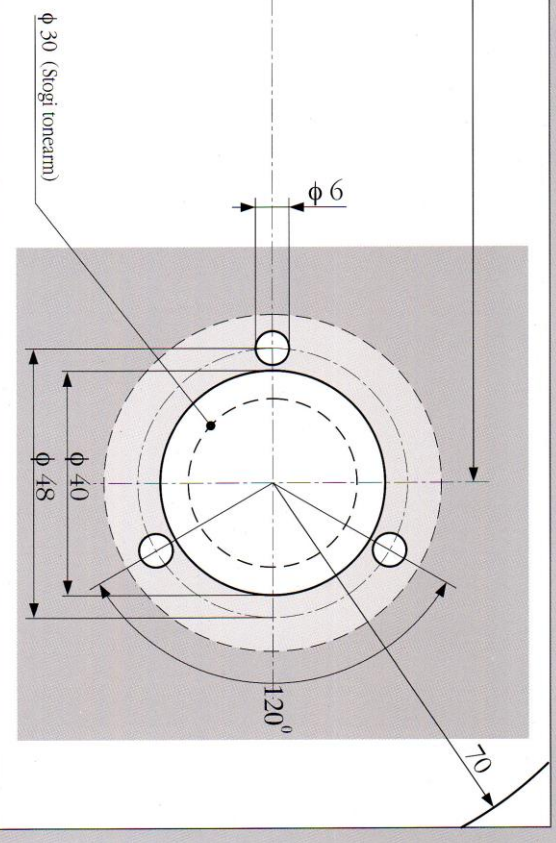

Cartridge Protractor (Not in correct scale) Tonearm mounting protractor